

Data Sheet



Article number: 339706250000

Description: Multibeam 6 Coupling 706.25.0000
Aluminium relieved & set screw hubs

Measures

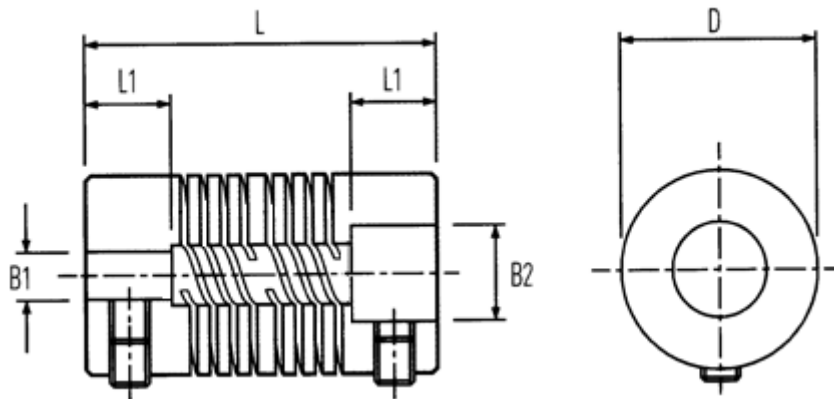

B1: Pre-drilled	= 5.0
B2: Pre-drilled	= 8.00
D	= 25.4
L	= 38.1
L1	= 11.0
Max angular displacement	= 0.38
Max B1 & B2	= 12.70
Max parallel displacement	= 7

Peak Torque NM	= 10.00
Set Screw	= M5